

Air heater type S21 to 800W

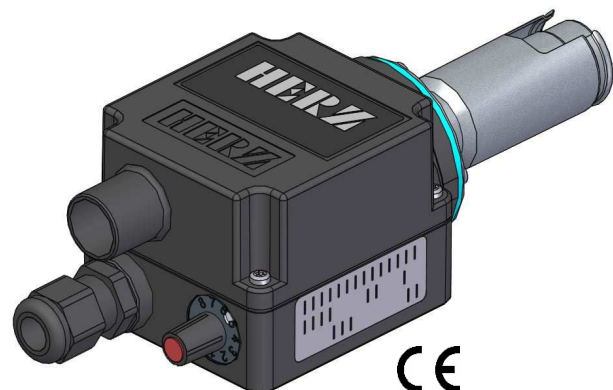

Function: Air heater with external air supply by means of fan or compressed air.
CAUTION !!! Device is not pressure-resistant !!!

Configuration: Default: Temperature control with potentiometer (1 – 8)
 - alternatively with external potentiometer (cable length 5 meter) or
 - external control by control unit or SPS (cable length 5 meter)
 Device is equipped with a reliable heating element protection. The integrated device protection turns off the device when tripped and resets automatically after cooling down. A reset is not required.

Features: Special designs:
 - for devices with electronic equipment max. supply air temperature 50°C/122°F
 - the unit is available without electronics (without heating element protection)
 - for devices without electronic equipment max. supply air temperature 80°C/176°F

Power:
Voltage: 550 Watt, 435 - 800 Watt
 120 VAC, 230 VAC

Technical data:

Item number / Basic versions	Potentiometer	5101354	5101349	5101351
	external control	5101343	5700043	5110304
	without electronic	on request	on request	5101352
Voltage	VAC	120	230	
Frequency	Hz	50 / 60		
Power	KW	0,55	0,435	0,8
Current	A	4,6	1,9	3,5
Max. temperature	°C°F	600/1112		
Min. air volume	l/min	150	110	210
Weight	kg	0,3		
Air intake	Ø mm	19		
Air outlet	Ø mm	13		
Heater tube	Ø mm	21		
Dimensions	mm (L x W x H)	194 x 70 x 59		
Conformity mark				
Protection class II				

Air heater type S21 to 800W

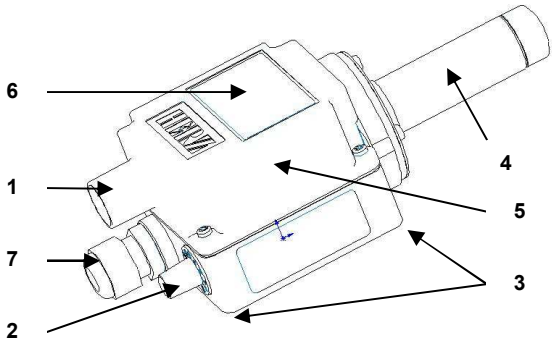
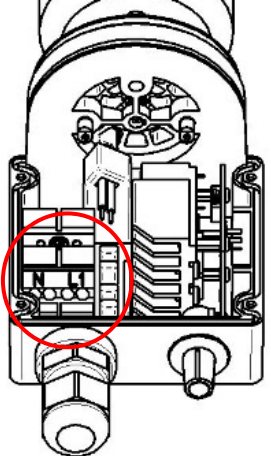
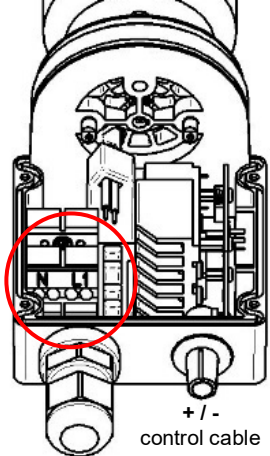
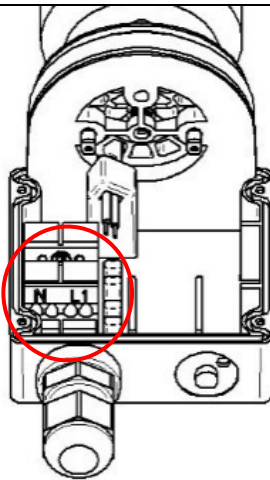
Product description:	Connection scheme:		
		<p>Default with potentiometer</p> <p>N, L1 = Main connection according to data plate</p>	 <p>External control</p> <p>N, L1 = Main connection according to data plate</p> <p>Digital signal (PWM max. 0,5Hz) 10-24VDC + = brown - = white</p>
<ol style="list-style-type: none"> 1. Cable fitting mains supply 2. Potentiometer 0-8 (control cable für ext. control); (no Potentiometer for devices without electronic) 3. Mounting on bottom of housing M 4 (screw depth 7 mm) 4. Heating element pipe Ø21mm 5. Cover 6. Data plate 7. Air intake Ø19mm 		<p>Version without electronics</p> <p>N, L1 = Main connection according to data plate</p>	

Air heater type S21 to 800W





Available versions:

Item no.	Description
5101354	Air heater S21 120 VAC 550 Watt with potentiometer
5101343	Air heater S21 120 VAC 550 Watt externally controllable (PWM 12-24 VDC, 1 Hz) with 5.0m control cable (2-pin)
5101349	Air heater S21 120 VAC 435 Watt with potentiometer
5700043	Air heater S21 120 VAC 435 Watt externally controllable (PWM 12-24 VDC, 1 Hz) with 5.0m control cable (2-pin)
5101351	Air heater S21 230 VAC 800 Watt with potentiometer
5110304	Air heater S21 230 VAC 800 Watt externally controllable (PWM 12-24 VDC, 1 Hz) with 5.0m control cable (2-pin)
5101352	Air heater S21 230 VAC 800 Watt without electronic

Available modifications:

Item number	Type	Modification	
5005005.1	S02	External potentiometer for heating including 5m control line; 3 pole; Potentiometer is soldered to the end of the cable; including potentiometer knob red;	The basic device for this modification is always standard with a potentiometer
5005021.1	S05	Internal PID control via internal potentiometer without digital display;	
5005010.1	S06	Internal thermocouple including 2m compensation cable with open ends green (+) white (-);	
5005007	S12	A push-in nipple for air hose 8/6mm is mounted on the air connection	
5005019	S13	Instead of the potentiometer for devices WITHOUT electronics, a 1/4 "compressed air hose connection 6/4mm is installed; This is used to monitor the pressure in the housing;	
5700141	S31	100% heating output with heating element protection for type S/M (for basic device without electronics);	

Accessories:

Item no.	Description
5107282	 Flange connector
5107144	 Tubular nozzle Ø 5mm
5107145	 Tubular nozzle Ø 10mm
5107324	 Spoon-reflector Ø 10 mm for soldering of solder-shrinkage connections and for shrinkage of PVC, PTFE, FEP shrink hose. Push-fit for nozzle Ø 5mm

Air heater type S21 to 800W

Combination possibilities for devices WITH electronic *:

Measuring point: 3.0 mm after the air outlet pipe adapter – without nozzle, measured at the hottest point
Hose length: 1,0 m
Air supply: Blower 400 Volt, 50 Hz (HD = High pressure blower, MD = Medium pressure blower)
Air flow: NI / min = standard liters per minute according to DIN 1343

CAUTION: Air flow and temperature are indicative which can change due to external influences and changes air hose diameter and length!

Blower type	Quantity, air heater type, voltage, power	Air flow at 50 Hz with heating [NI / min.]	Maximum temperature at 50 Hz [°C/°F]
HD140	1 x S21; 230VAC; 435W	230	290/554
	2 x S21; 230VAC; 435W	2 x 200	300/572
	4 x S21; 230VAC; 435W	4 x 160	310/590
	1 x S21; 230VAC; 0,8KW	330	320/608
	2 x S21; 230VAC; 0,8KW	2 x 240	380/716
	4 x S21; 230VAC; 0,8KW	4 x 190	430/806

*Data without guarantee

Air heater type S21 to 800W

<p>* nicht lieferbar / not for sale</p>		<p>Maßblatt Dimension sheet</p>	<p>Typ / Type: S21 mit Schutzrohr</p>	<p>Zeichnung / Drawing Nr. / No.: 19.04.2018 geändert: 19.04.2018</p>	<p>Name: Rauter Seite: 1/1</p>
---	--	--	--	---	--

Änderungen vorbehalten / Changes reserved

Air heater type S21 to 800W

HERZ GmbH

Kunststoff- & Wärmetechnologie
Biberweg 1
DE – 56566 Neuwied
Tel.: +49 (0)2622-8855-0
Fax: +49 (0)2622-8855-135
Fax: +49 (0)2622-8855-136
www.herz-gmbh.com
info@herz-gmbh.com

HERZ Austria GmbH

Kunststoff- & Wärmetechnologie
Gleinser Weg 27
AT – 6141 Schönberg / Tirol
Tel.: +43 (0)5225-63113
Fax: +43 (0)5225-6311385
www.herz-austria.at
herz.schoenberg@herz-gmbh.com

HERZ Hungária Kft.

Műanyag- és hőlégtéchnika
Pesti út 284
HU – 2225 Üllő
Tel.: +36 (06)29-522400
Fax: +36 (06)29-522410
www.herz-hungaria.hu
herz@herz-hungaria.hu

HERZ Bulgaria OOD

Boul. Assen Yordanov 10
BG – 1592 Sofia
Tel.: +359 (0)2-9790351
www.herz-bulgaria.com
office@herz-bulgaria.com

HERZ GmbH

Kunststoff- & Wärmetechnologie
Am Arenberg 26A
DE – 86456 Gablingen
Tel.: +49 (0)8230-85085
Fax: +49 (0)8230-85087
www.herz-gmbh.com
robert.einberger@herz-gmbh.com

HERZ Austria GmbH

Kunststoff- & Wärmetechnologie
Johann-Galler-Str. 20 IZ – NÖ – Nord
AT – 2120 Wolkersdorf i. Weinviertel
Tel.: +43 (0)2245-82494-0
Fax: +43 (0)2245-82494-9
www.herz-austria.at
herz.wolkersdorf@herz-gmbh.com

HERZ Polska Sp.z o. o.

Technologie obróbki tworzyw sztucznych
Ul. Kostrzyńska 30
PL – 02-979 Warszawa
Tel.: +48 (0)22-8428583
Fax: +48 (0)22-8429700
www.herz-polska.pl
herz@herz-polska.pl