

High pressure blower type HD140



Type:	Side channel blower
Configuration:	In the standard version, the fan on the intake side has a stainless steel filter that can be used after cleaning with compressed air. When using a fine filter, the stainless steel filter be removed.
Features:	The device is suitable for operation with frequency inverters for speed control. If desired, the device can be equipped with a thermistor (PTC), the signal can be evaluated with an optional trip device. The tech. Data remains unchanged.
Operating temperature:	The operating temperature of the radial pressure may NOT exceed 60 ° C .
Ambient temperature:	-20 ° C to +60 ° C;
Voltage:	Optional 1 x 230VAC/50Hz, Capacitor 16/450uF/V (Item-no.: 5108623)

Technical data

Type:	Side channel blower		
Item no.:		5103429	on request
Voltage	VAC (Y/Δ)	200 – 255 / 346 - 440	200 – 247 / 346 – 480
Frequency	Hz	50	60
Motor power	KW	0,42	0,52
Current	A (Y/Δ)	1,73 – 2,10 / 1,00 – 1,20	2,00 – 2,50 / 1,15 – 1,45
Volume flow	m³ / min	1,50	1,60
Total pressure difference	Pa	14'000	
Speed	rpm	2'845	3'435
Sound pressure level	LpA (db)	64 – 73	69 – 76
Weight	kg	11,3	
Air intake	mm	Ø 38 (aussen)	
Air outlet	mm	Ø 38 (aussen)	
Dimensions	mm (LxWxH)	283 x 244 x 266,5	
Protection type		IP 54	
Conformity		CE	
Protection class I			

High pressure blower type HD140

Fan characteristics

(Y/Δ) 200–255/346–440VAC, 50Hz

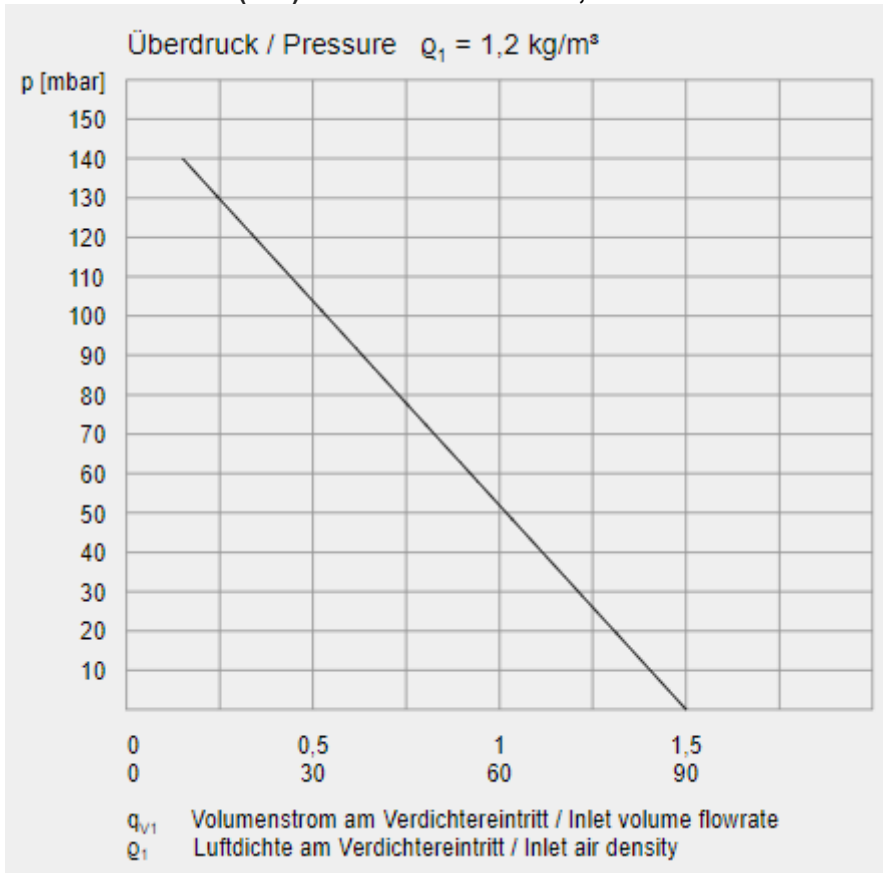

(Y/Δ) 200–277/346–480VAC, 60Hz

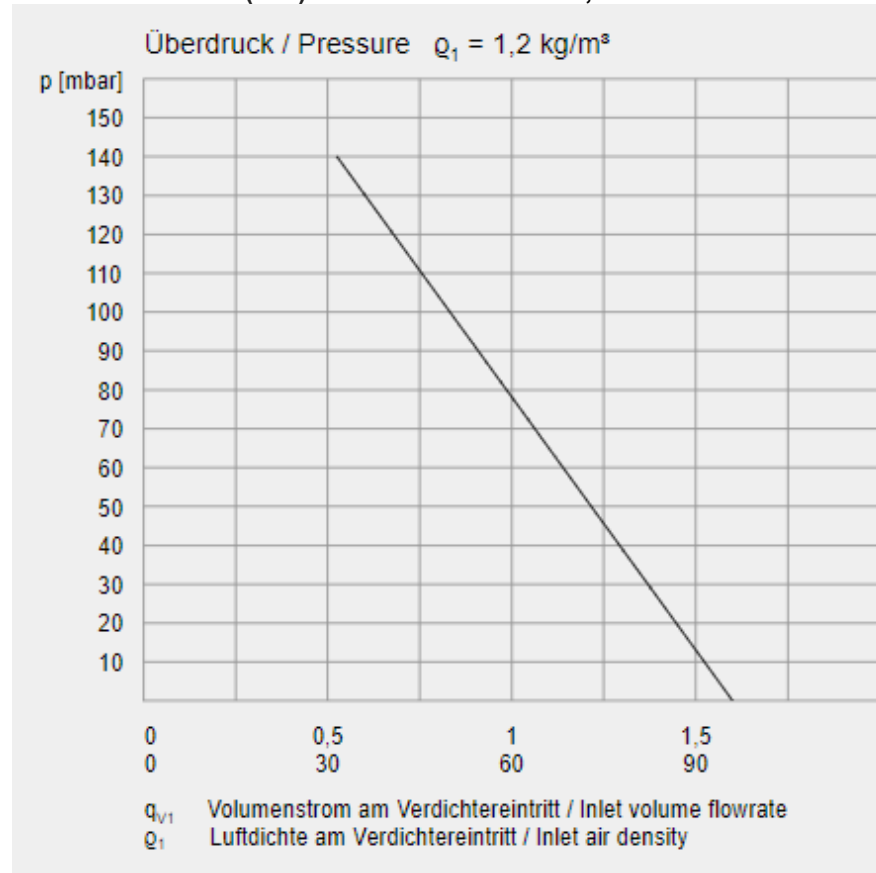













Permissible vibration values according to ISO 14694

Fan application category [a_n]	Rigidly mounted [mm/s^2]		Flexibly mounted [mm/s^2]	
	Peak	r.m.s.	Peak	r.m.s.
BV-3	3,8	2,8	5,1	3,5

High pressure blower type HD140

Accessories

Item-No.		Description
5108623		Motor capacitor 230 V ~ with clamp and cable
5107293		Hose connection adaptor 1 x 38mm inside / 2 x 38mm outside
5207293		Hose connection adaptor 1 x 38mm / 2 x 38mm – with thread outside
5107281		Hose connection adaptor 1 x 38mm inside / 3 x 14mm outside
5107298		Hose connection adaptor 1 x 38mm inside / 2 x 19mm outside
5107286		PVC air hose – Ø 38mm inside
5107287		Hose clip for hose Ø 38mm
5107241		Closure Cap for hose connection adaptor Ø 38mm
5107350		PVC air hose aus PVC – Ø 19mm inside
5107290		Hose clip for hose Ø 19mm
5107242		Closure Cap for hose connection adaptor Ø 19mm
5107354		Stainless steel filter for HD140

High pressure blower type HD140

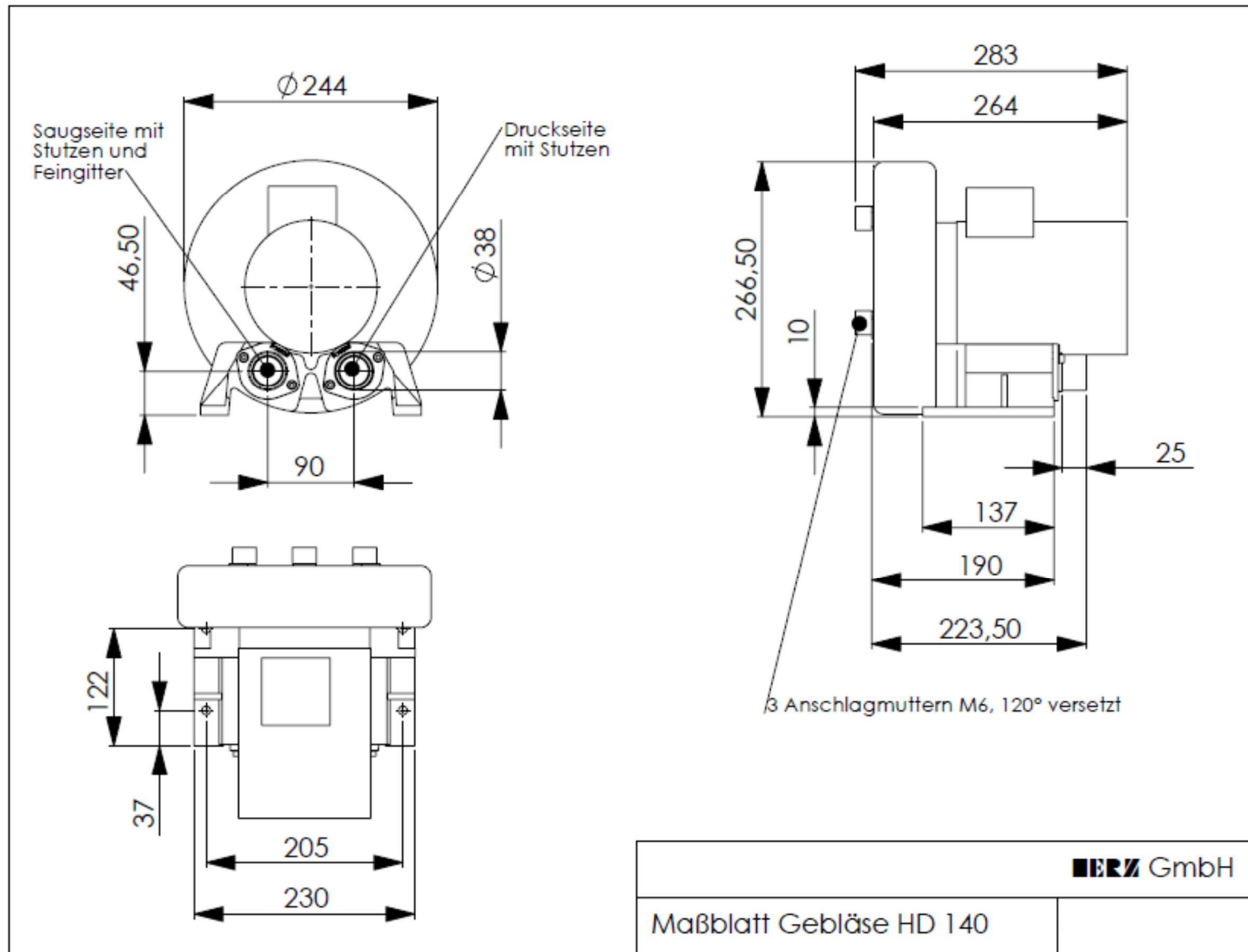

High pressure blower type HD140

HERZ GmbH

Kunststoff- & Wärmetechnologie
Biberweg 1
DE – 56566 Neuwied
Tel.: +49 (0)2622-8855-0
Fax: +49 (0)2622-8855-135
Fax: +49 (0)2622-8855-136
www.herz-gmbh.com
info@herz-gmbh.com

HERZ Austria GmbH

Kunststoff- & Wärmetechnologie
Gleinser Weg 27
AT – 6141 Schönberg / Tirol
Tel.: +43 (0)5225-63113
Fax: +43 (0)5225-6311385
www.herz-austria.at
herz.schoenberg@herz-gmbh.com

HERZ Hungária Kft.

Műanyag- és hőlégtéchnika
Pesti út 284
HU – 2225 Üllő
Tel.: +36 (06)29-522400
Fax: +36 (06)29-522410
www.herz-hungaria.hu
herz@herz-hungaria.hu

HERZ Bulgaria OOD

Boul. Assen Yordanov 10
BG – 1592 Sofia
Tel.: +359 (0)2-9790351
www.herz-bulgaria.com
office@herz-bulgaria.com

HERZ GmbH

Kunststoff- & Wärmetechnologie
Am Arenberg 26A
DE – 86456 Gablingen
Tel.: +49 (0)8230-85085
Fax: +49 (0)8230-85087
www.herz-gmbh.com
robert.einberger@herz-gmbh.com

HERZ Austria GmbH

Kunststoff- & Wärmetechnologie
Johann-Galler-Str. 20 IZ – NÖ – Nord
AT – 2120 Wolkersdorf i. Weinviertel
Tel.: +43 (0)2245-82494-0
Fax: +43 (0)2245-82494-9
www.herz-austria.at
herz.wolkersdorf@herz-gmbh.com

HERZ Polska Sp.z o.o.

Technologie obróbki tworzyw sztucznych
Ul. Kostrzyńska 30
PL – 02-979 Warszawa
Tel.: +48 (0)22-8428583
Fax: +48 (0)22-8429700
www.herz-polska.pl
herz@herz-polska.pl